

REED

Model C-370

Digital RTD Thermometer

Instruction
Manual



[www reedinstruments com](http://www.reedinstruments.com)

Table of Contents

Features.....	3
Specifications.....	3-4
Instrument Description	5-6
Operating Instructions.....	7-9
Temperature Measurement	10
Temperature Meter Calibration Setup	10-14
<i>Pt type selection</i>	11
<i>0°C Calibration</i>	12-13
<i>Recall default factory setting value</i>	14
Battery Replacement.....	15
Product Maintenance	16
Temperature Probe.....	16

For service on this or any other REED product or information on other REED products, contact REED Instruments at info@reedinstruments.com.

Features

This digital RTD thermometer is to be used with platinum-type temperature sensors. The temperature indication follows the IEC751 temperature table for PT-type sensors.

- IP67 waterproof housing
- Platinum resistor temperature sensor requires less temperature compensation than thermocouple units
- 4-digit LCD readout with LED backlight
- °C/°F switchable
- Min/Max/Avg functions
- Relative mode and Data hold
- Low battery indication with auto power off
- Includes piercing type temperature probe (Pt-100, IEC751 Class A accuracy)
- Ideal for food service applications

Specifications:

Measurement Range:	-100°C ~ 300°C; -148°F ~ 572°F
Resolution:	0.1°C; 0.1°F;
Sensor types:	Platinum resistance temperature sensor for pt-100, pt-500, pt-1000 (selectable) 4 wires ALPHA=0.003850
Measurement current:	Approx 0.53mA
Maximum Voltage at thermocouple input:	60V DC, or 24Vrms AC

continued ...

Environmental:

- Operating Temperature and Humidity:
0°C ~50°C (32°F - 122°F); 0 - 80% RH
- Storage Temperature and Humidity:
-10°C to 60°C (14°F - 140°F); 0 - 80% RH
- Altitude up to 2000 meters

Accuracy (at 23 ± 5°C):

Range	Accuracy
-100°C ~ 300°C	±(0.1% reading + 0.4°C)
-148°F ~ 572°F	±(0.1% reading + 0.8°F)

Temperature Coefficient:

For ambient temperatures from 0°C to 18°C and 28°C to 50°C, for each degree celcium ambient below 18°C or above 28°C add the following tolerance into the accuracy specification ...

0.01% of reading + 0.03°C (0.01% of reading + 0.06°F)

The basic accuracy Specification does not include the error of the probe, refer to the probe accuracy specifications (on page 16) for additional details.

Sample Rate:	2 times per second
Water resistance:	IP67
Power Supply:	Battery 1.5V x 3 size AAA
Battery Life:	Approx. 100 hours with alkaline batteries
Dimensions:	150 × 66 × 31mm
Weight:	175g Approx.
Accessories:	Pt-100 Probe (class A) (model TP-R01), batteries and instruction manual
Optional Accessories:	Pt-100 Probe (class A) (model TP-R01), soft carrying case (model CA-05A)

Instrument Description





- 1 – Pt type temperature sensor connector
- 2 – LCD display
- 3 – Power ON/OFF button
- 4 – HOLD button
- 5 – MAX/MIN/Average control button
- 6 – Back light button
- 7 – Relative readout button
- 8 – °C/°F control button

continued ...

Display

Symbol definitions
and button locations



-	This indicates that the minus temperature is sensed
°C/°F	Celcius and Fahrenheit indication
Pt xxx	Platinum Type Indication
HOLD	This indicates that the display data is being held
MAX	The Maximum value is being displayed
MIN	The Minimum value is being displayed
AVG	The Average value is being displayed
ΔREL	The reading is under Relative Mode
	The battery power level indication
	This indicates Auto Power Off is enabled

Operating Instructions

Turning the meter on

Press the **I** button to turn the thermometer ON or OFF.

Connecting the temperature probe

For measurement, plug the temperature probe into the input connectors.

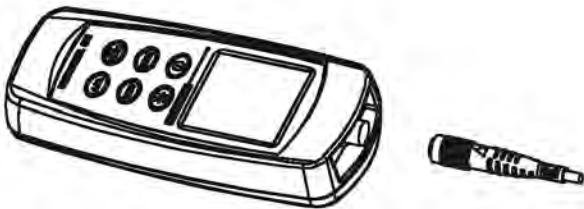

Selecting the Temperature Scale

When the meter is first turned on, the default scale setting is set to the Celsius (°C) scale. It can be changed to Fahrenheit (°F) by pressing “**C/°F**” button and vice versa back to Celsius.

Data-Hold Operation

To hold the present reading and keep it on the display, press the “**HOLD**” button. When the hold data is no longer needed, release the data-hold operation by pressing “**HOLD**” button again.

When the meter is under Data Hold operation, the “**ΔREL**”,



and “**C/°F**” buttons are disabled.

Back light Operation

Press the “**Back Light**” button to turn the back light on, press it once again to turn it off.

The meter will turn the back light off automatically if the “**Back Light**” button is not pressed after 10 seconds.

continued ...

Relative Operation

When the “**ΔREL**” button is pressed, the meter will memorize the present reading and the difference between the new reading and the memorized reading and the result will be shown on the display. Press the “**ΔREL**” button again to exit the relative operation.

MAX/MIN/AVG Operation

When the  button is pressed, the meter will enter the MAX/MIN/AVG mode. Under this mode the maximum value, minimum value and average value will appear simultaneously. The average value is calculated using the last 8 readings from the memory, it will update with every new reading.

When the MAX symbol is displayed, the Maximum value is shown on the display.

Press  again and the MIN symbol is on the display and also the minimum reading.

Press  again and the AVG symbol is on the display as well as the average reading.

Press  again and the MAX, MIN and AVG will blink together. This means that all these readings are updated in the memory and the reading is the current temperature.

Press  to circulate the display mode among these options.

When the meter is under  operation, the “**ΔREL**” and “**°C/°F**” functions are disabled.

To exit the MAX/MIN mode, one may press and hold  for two seconds.

continued ...



Auto Power Off

By default, the meter is in auto power off mode. The meter will power itself off after 30 minutes without operation.

To disable the auto power off, press and hold the “**HOLD**” button and turn the meter on. There will be two successive beeps to indicate that the auto power off has been disabled.

Low Battery

This meter indicates the battery power level directly on the display. Use this reference guide to establish battery power level.

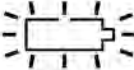
	Battery power level is FULL, you can still take measurements.
	Battery power level is LOW, the battery will need to be replaced, you can still take measurements.
	Battery power level is EMPTY, the batteries need to be replaced (size AAA, 1.5V x 3). You can no longer take measurements.

For complete instructions on how to replace the batteries see page 15.

For service on this or any other REED product or information on other REED products, contact REED Instruments at info@reedinstruments.com.

Temperature Measurement

Correct Measurement Method

The temperature sensor is located at the end of the metal sheath of the sheath type temperature probe. To accurately test internal temperatures, insert the probe to a distance of at least 15 times the diameter of the sheath directly into the item you want to measure.

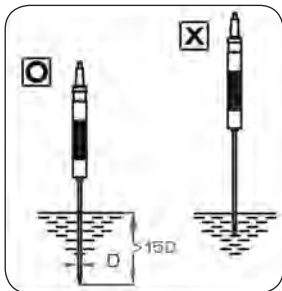

Connector Configuration

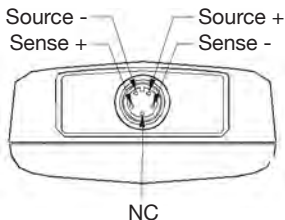

Temperature Meter Calibration Setup

This diagram shows the button functions when you are entered into calibration mode.

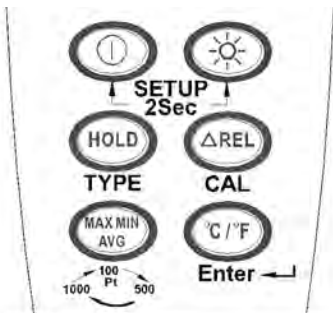

Turn the power “OFF” before attempting the following SETUP procedures. The setup mode will be cancelled if during the following procedures the “POWER” button is pressed.

Pt type selection



Press and hold the “**Power**” and “**Light**” buttons for 2 seconds to enter setup mode.

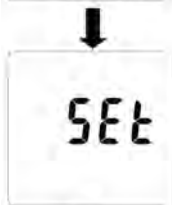

Press the “**Hold**” button to enter the Pt selection mode.

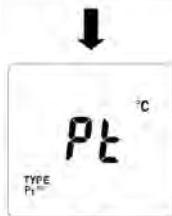

Press the “**Max**” button to select between Pt probe type (Pt100, Pt500, Pt1000 is circulate).

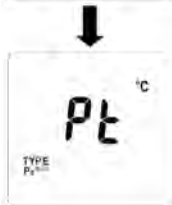

Press the “°C/°F” button to confirm selection.

0°C Calibration



Insert temperature probe into a 0°C standard calibrator unit before calibration. Hold the probe until condition is stabilized before starting calibration.



Press and hold the “**Power**” and “**Light**” buttons for 2 seconds to enter setup mode.



Press the “**ΔREL**” button to enter calibration mode. Enter Pt selection first.



Press the “**°C/°F**” button to confirm Pt selection.



Press the “**ΔREL**” button to enter calibration mode.

continued ...



Press the “**ΔREL**” button to confirm present calibration value.



Press the “**°C/°F**” button to confirm selection.

Recall Default factory setting value



Press and hold the “**Power**” and “**Light**” buttons for 2 seconds to enter setup mode.



Press the “**ΔREL**” button to enter calibration mode. Enter Pt selection first.

Recall Default factory setting value



Press the "°C/°F" button to confirm Pt selection



Press the "Light" button to enter recall mode.



Press the "°C/°F" button to confirm revert back to "Default factory setting value"



Press the "°C/°F" button to confirm selection.

Battery Replacement

- 1) Remove all of the back cover screws to be able to remove the cover.
- 2) Verify the polarity of the batteries and install the new LR03 (AAA size) alkaline batteries into the instrument.
- 3) Replace cover properly onto the meter and tighten screws.



The unit's back cover is fitted with rubber rings. After replacing the batteries, check that the rubber rings are properly placed before reinstalling the back cover. Improper placement of the rubber rings will compromise the unit's water-resistant structure, and possibly result in damage to the meter.

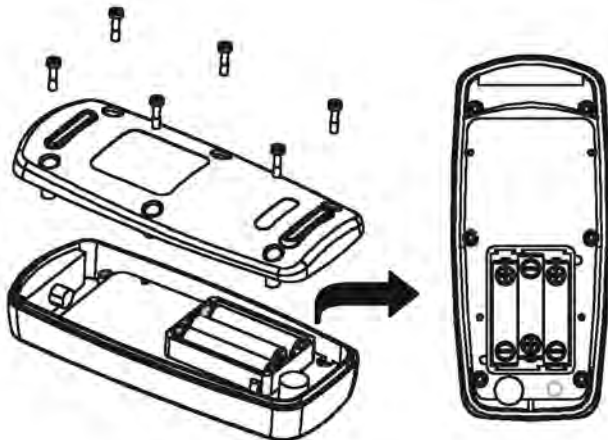

Product Maintenance

In order to ensure the accuracy of the thermometer for a long period of time it should be calibrated once a year. For service (repairs or calibration) on this or any other REED product or information on other REED products, contact REED Instruments at info@reedinstruments.com.

Clean the device and the window of the display with a clean, lint-free, antistatic and dry cleaning cloth.



Do not use cleaning agents that contain carbon or benzenes, alcohol or anything similar to clean the meter as these substances will damage the surface of the meter.

Do not use tools with sharp edges, screwdrivers, metal brushes or anything similar to clean the meter.

Temperature Probe

Piercing type temperature probe

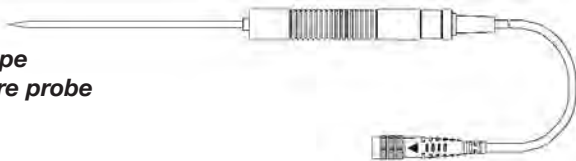

Piercing type temperature probe Specification

Sensor Type	Platinum resistance thermometer sensor Pt 100 (4 wires)
Accuracy	IEC751, class A $\pm 0.15^{\circ}\text{C} \pm 0.002$ measurement temperature
Measurement Range	-100 to 400°C
Temp. Sensor Dim.	Approx. $\varnothing 3.2\text{mm}$ ($\varnothing 0.125''$)
Temp. Sensor Length	Approx. 120 mm (4.72'')
Cable Length	Approx. 1100 mm (43.3'')
Water-resistant	EN60529:1991, IP67